

## Seismic Performance of Shallow Underground Subway Stations in Soft Soil

Khani S., \*Homami P.; Department of Civil Engineering,  
Kharazmi University

Received: 6 June 2012

Revised 12 May 2013

### Abstract

In the recent years there was a great improvement in the development of underground structures. Due to the increase in the costs of constructions and the importance of the safety in transportation, attention has been focused on the hazards of earthquakes. In this paper, the effect of earthquakes and the importance of seismic analysis are described. The analysis method is presented briefly, and then the simplified analysis of Hashash et al. (2001) is used. Two metro station structures under two different seismic hazard levels were analyzed. Pushover analysis method is also used which is a simple and static non-linear method in seismic analysis and design of structures. In this non-linear analysis, the target displacement is computed by the simplified frame analysis model. The finding of this study showed that the structure behavior was remained elastically to a large extent of displacement using this method. Hence, the design of the structures based on the performance level or reduction of the moment extracted from the Hashash et al. (2001) method is recommended.

**Keywords:** Underground structures, Pushover analysis, Metro station, Seismic design, Hashash method

---

\*Corresponding author

homami@khu.ac.ir

## Introduction

Prior to the severe damages of some tunnels and subways, it was thought that underground facilities would be safe during earthquakes and they have better earthquake performance than super-structures because of their embedment with soil or rock. But recent damages during Japan earthquake, the 1999 Chi-Chi Taiwan earthquake, the 1999 Kocaeli Turkey earthquake [1] have drawn the attention of researchers to the analysis and design of this type of structures.

The different characteristics of super-structures and underground structures lead to different design and analysis approaches. Force method is used for super-structures in which the seismic loads are largely expressed in terms of inertial force. On the other hand, the deformation method is used for underground structures. In this method, the design and analysis are based on the consistence of the displacement of the structure and the ground. Seismic response of underground structure is dependent on the deformation induced by earthquake [2]. The Mononobe-Okabe theory is mostly used for determining the increase of lateral earth pressure due to seismic effect. The dynamic earth pressure is considered to be made by the inertial force of the surrounding soils and is calculated by relating the dynamic pressure to a determined seismic coefficient and soil properties [2]. The application of this method has shown reasonable safety against dynamic earth thrust for tunnels buried at shallow depths (e.g. in the Los Angeles Metro Project). In Wood method

(1973) [3], the calculated thrust is approximately 1.5-2 times of the thrust of Mononobe-Okabe Method [3]. Yong (1985) [4] concluded that this method is possibly adequate for a volume structure that is surrounded in stiff medium and rigidly braced across, so this method like the Mononobe-Okabe Method would lead to unrealistic results and is not recommended. The free-field shear deformation method is another procedure for seismic analysis of underground structures. In this method, the racking deformation of a tunnel is assumed to be conformed to the shear deformation of the soil. With this assumption, the racking stiffness of the structure is ignored [2], so it is necessary to use a method for analyzing tunnel structure which considers interaction between soil and structure. This method should not be complex like finite element analysis; hence, a simplified frame analysis can provide an adequate design approach for designing rectangular structures [1, 2].

The pushover analysis on Daikai station was carried out by Lio-Jingbo (2008) [5]. The static elasto-plastic method was used to study the seismic response and failure mechanism of the structure. This study indicated that the pushover analysis results conform to the real seismic damages, so, it is verified that pushover analysis is a reasonable and applicable approach [5]. Lio-Jingbo (2009) [6] also studied the applicability of the pushover method by changing some parameters like the burial depth of the structure, the stiffness of the soil and the concrete strength of the structure, respectively. The results obtained

through the pushover method were compared to the results of static-dynamic analysis based on the viscous-spring artificial boundary [6]. It was found that the results of the two methods are in good agreement; so the pushover analysis is suitable for the seismic analysis and design of underground structures according to high applicability and a good computational accuracy. In this paper, the pushover analysis is applied on two metro stations using the simplified frame analysis for determining target displacement of these structures, due to their performance levels.

### **The Effects of Earthquakes on Rectangular Structures**

Shallow depth tunnels often have a rectangular shape and are built using the cut-and-cover method. Seismic characteristics of box structures and circular tunnels are different because of the following three issues of concern:

1. The shallow depth tunnels are more vulnerable than the deeper ones, because the shaking intensity and seismic deformation of the ground in upper layers are usually greater than deeper layers, due to the lower stiffness of the soil.
2. The dimensions of rectangular tunnels are usually greater than the circular tunnels. The static loads are not transmitted by the box structures as circular tunnels, so the wall and the slabs of these tunnels should be thicker and, therefore, stiffer. Due to higher

stiffness and larger deformation, it is essential to consider the interaction between the soil and structure.

3. The backfill soil may be a compacted material which has different properties relative to the natural soil. This fact should be considered in the design and analysis [2].

### **Racking Effect**

The racking deformation (side way motion) is experienced in rectangular tunnels due to the shear distortion of the ground during earthquakes. The most resultant damage is the distress at the top and bottom joints for rigid frame structures. Some of the damages were reported during the earthquakes of 1906 San Francisco and 1971 San Fernando [7]. The damages included:

- Concrete spalling and longitudinal cracks along the walls;
- Failure at the top and bottom wall joints;
- Failure of longitudinal construction joints.

### **Seismic Analysis Methods**

#### **1. The free-field racking deformation method**

The free-field deformation is simple and effective. For example, when the ground is very stiff, the ground distortion is small and the intensity of shaking is low [2]. This method has also been used successfully in several major transportation projects for seismic design

of tunnels [8]. However, it made a conservative design in rectangular tunnels when the structure and the surrounding soil are soft [9].

Soft soil seismically induced large free-field ground distortion. The stiff structure may actually deform less than the soft ground. So the soil-structure interaction effect on the racking of a rectangular tunnel should be considered.

## **2. Soil-structure interaction finite element analysis**

Analysis of tunnel-ground interaction considers both the tunnel and ground stiffness. This method is useful for complicated tunnel geometry and every ground condition, but there are some disadvantages as follow:

- i) It requires complicated and time consuming computer analysis;
- ii) Uncertainty of seismic input parameters can make the uncertainty of analysis several times bigger; so in this study, simplified frame analysis is used.

## **3. Simplified frame analysis method**

The soil-structure interaction effect has been calculated by means of a series of dynamic finite element analysis. It shows a good approximation of soil-structure interaction and the formulation is easy with reasonable accuracy in determining structure response [2].

The steps of this procedure are presented below:

- 1) The soil-rock properties should be determined based on the results of laboratory investigations.

- 2) The earthquake design parameters should be derived. These parameters should include peak ground acceleration, velocity, displacement for both maximum design earthquake (MDE: an event with probability of exceeding during the life of facility between 3 and 5%) and operating design earthquake (ODE: an event with probability of exceeding between 40 and 50%)
- 3) Based on the steps 1 and 2, Tables 1 and 2 can be used to relate the peak ground acceleration to estimate peak ground velocity and displacement at surface, respectively. Because earth quake damage to underground structure has proven to be better conformed to velocity and displacement.
- 4) Ground motion generally decreases with depth [11] in the absence of more accurate data. Table 3 can be used to determine the relationship between ground motion and depth of the tunnel.

**Table 1. Ratios of peak ground displacement to peak ground acceleration at surface in rock and soil [10]**

| Moment magnitude ( $M_w$ ) | Ratio of peak ground velocity (cm/s)<br>To peak ground acceleration (g) |       |        |
|----------------------------|---|-------|--------|
|                            | Source-to-site distance (km)  |       |        |
|                            | 0-20  | 20-50 | 50-100 |
| Rock                       |   |       |        |
| 6.5                        | 66  | 76    | 86     |
| 7.5                        | 97  | 109   | 97     |
| 8.5                        | 127   | 140   | 152    |
| Stiff soil                 |   |       |        |
| 6.5                        | 94  | 102   | 109    |
| 7.5                        | 140   | 127   | 155    |
| 8.5                        | 180   | 188   | 193    |
| Soft soil                  |   |       |        |
| 6.5                        | 140   | 132   | 142    |
| 7.5                        | 208   | 165   | 201    |

8.5                      269                      244                      251

**Table 2. Ratios of peak ground velocity to peak ground acceleration at surface in rock and soil [10]**

| Moment magnitude<br>( $M_w$ ) | Ratio of peak ground velocity (cm/s)<br>To peak ground acceleration (g) |       |        |
|-------------------------------|---|-------|--------|
|                               | Source-to-site distance (km)  |       |        |
|                               | 0-20  | 20-50 | 50-100 |
| Rock                          |   |       |        |
| 6.5                           | 18  | 23    | 30     |
| 7.5                           | 43  | 56    | 69     |
| 8.5                           | 81  | 99    | 119    |
| Stiff soil                    |   |       |        |
| 6.5                           | 35  | 41    | 48     |
| 7.5                           | 89  | 99    | 112    |
| 8.5                           | 165   | 178   | 191    |
| Soft soil                     |   |       |        |
| 6.5                           | 71  | 74    | 76     |
| 7.5                           | 178   | 178   | 178    |
| 8.5                           | 330   | 320   | 305    |

**Table 3. Ratios of ground motion at depth to motion at ground surface [10]**

| Tunnel depth (m) | Ratio of ground motion at tunnel depth to motion at ground surface |
|------------------|--|
| ≤6               | 1.0  |
| 6-15             | 0.9  |
| 15-30            | 0.8  |
| >30              | 0.7  |

- 5) The simplified procedure provides a reasonable estimation of the maximum free-field shear strain ( $\gamma_{max}$ ). It can be expressed as:

$$\gamma_m = \frac{V_s}{C_s} \quad (1)$$

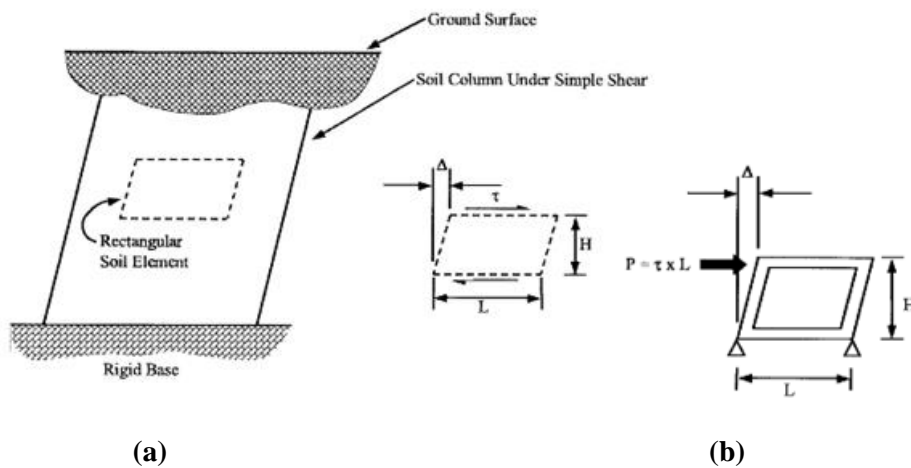
where  $C_s$  is shear wave velocity and  $V_s$  is peak ground velocity.

The final results of this step provide the free-field deformation as depicted in Figure 1.

- 6) The relative stiffness is determined (the flexibility ratio) between the free-field medium and the structure

$$F = \frac{G_m W}{S_1 H} \quad (2)$$



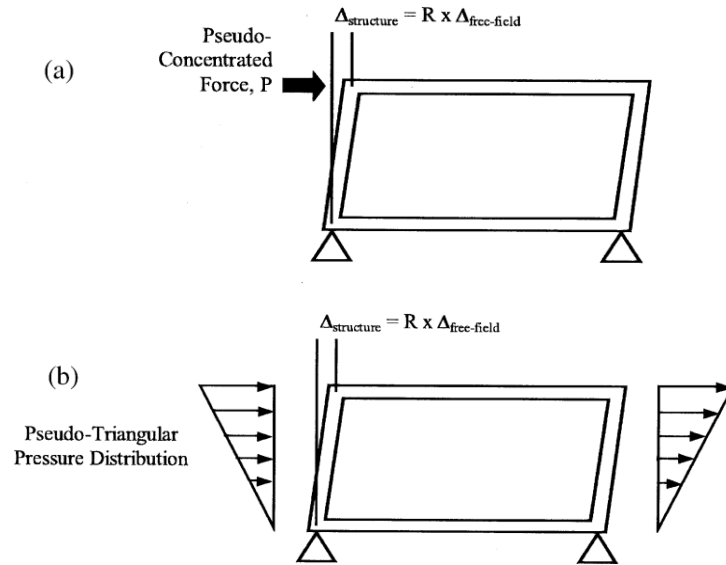


**Figure 1. Relative stiffness between soil and a rectangular frame [2]. a) Flexural (shear) distortion of free-field soil medium, b) Flexural (racking) distortion of a rectangular frame**

where  $W$  is the width of the structure and  $S_1$  is the stiffness of the structure. However in this formula, the unit racking stiffness is simply the inverse of the lateral racking deformation that is caused by a unit concentrated force.

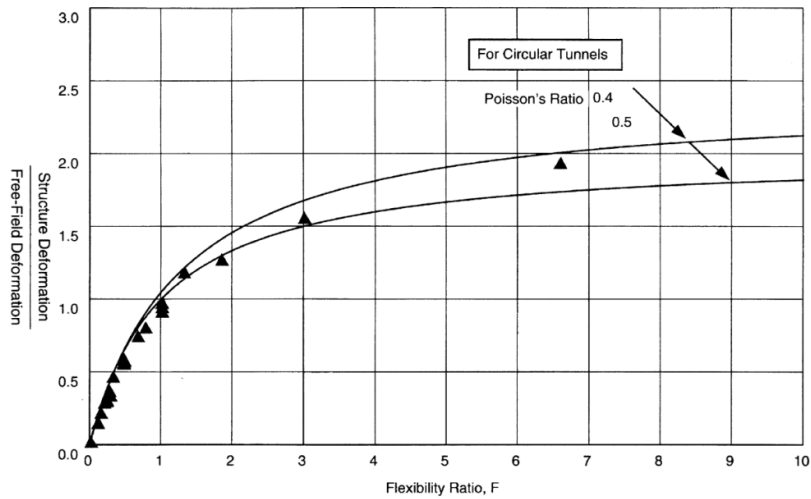
$$S_1 = \frac{1}{\Delta} \quad (3)$$

- 7) Racking coefficient  $R$  is calculated based on the flexibility ratio obtained from step 6 and using this data as displayed in Figure 3.
- 8) The seismically induced racking deformation  $\Delta_{\text{Structure}}$  is imposed upon the structure in a simple frame analysis as depicted in Figure 2.

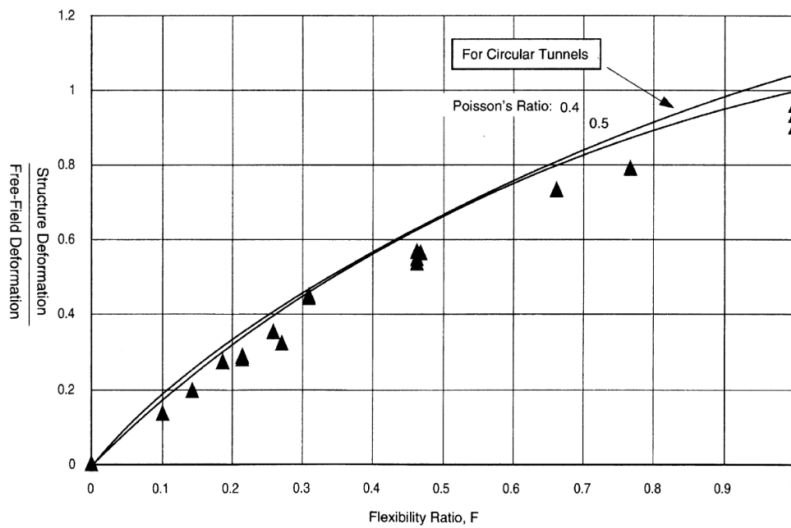


**Figure 2. Simplified frame analysis models [2]: a) pseudo-concentrated force for deep tunnels; b) pseudo-triangular pressure distribution for shallow tunnels**

Concentrated force model (Figure 3 a) is used for deeply buried rectangular tunnels and the shear force at the exterior surface of the roof is caused the racking of the structure.



Filled Triangular Symbols: For Rectangular Tunnels  
 Solid Lines: For Circular Tunnels



Filled Triangular Symbols: For Rectangular Tunnels  
 Solid Lines: For Circular Tunnels

**Figure 3. Normalized structure deflections, circular vs. rectangular tunnels [2]**

So, the  $\Delta_{Structure}$  can be given in Equation 4:

$$\Delta_{Structure} = \Delta_{free-field} \times R \tag{4}$$

For shallow rectangular tunnels as the soil cover decreases, the shear force at the interface of the soil-roof will decrease. The external force caused racking in the structure from shear force at the soil-roof interface shifts to the normal earth pressure along the sidewall. The racking deformation ( $\Delta_S$ ) should be imposed as a triangular pressure distribution along the wall instead of a concentrated force.

## Material and Models

### Linear and Nonlinear Analysis of the Subway Stations

In this analysis, earthquake and ground parameters of tunnels are depicted in Table 4. Earthquake characteristics were determined according to the seismic hazard analysis of the chosen site in a high seismic zone.

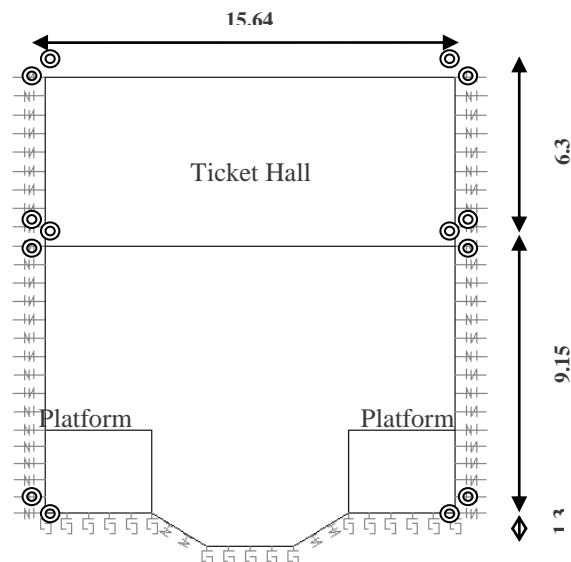
**Table 4. Ground Parameters and Properties**

|           | overburden depth (m) | $K_0$    | $K_a$    | $\gamma$ ( $t/m^3$ ) | $C_s$ (m/sec) | $A_g$ in middle depth |       |
|-----------|----------------------|----------|----------|----------------------|---------------|-----------------------|-------|
|           |                      |          |          |                      |               | ODE                   | MDE   |
| Station 1 | 2.5                  | 0.5<br>3 | 0.3<br>9 | 1.95                 | 368           | 0.175g                | 0.45g |
| Station 2 | 3                    | 0.5      | 0.3<br>6 | 2                    | 412.3         | 0.175g                | 0.41g |

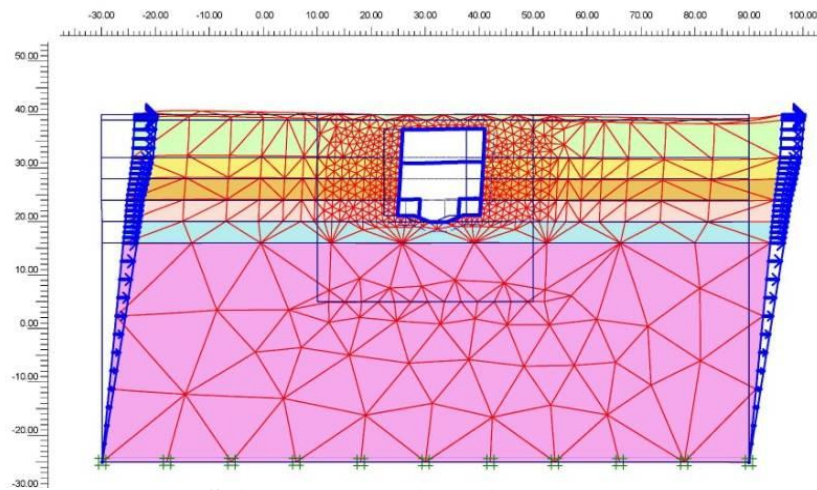
Tunnel-ground system is simulated as an elastic beam on elastic foundation in SAP2000 software. In order to make the model closer to the reality and to consider the interaction of soil-structure, gap elements are used which is able to transfer compression forces between the soil and the structure like a spring type member and

unable to transfer tension forces. As it is shown in Figure 4, it is considered 14 plastic hinges for determining performance level of metro stations with pushover analysis.

In this study the effects due to dead load(D), live load(L), horizontal loads of earth (soil-H) and earthquake motion for two different levels(EQ MDE) and (EQ ODE) in two vertical direction are considered into seismically loading combination that are presented in ACI 318-05 [12]. In this study, water pressure is neglected, but the vertical seismic force is applied on the roof of the tunnel structures. The metro station considering the above assumptions is linearly analyzed. The result of simplified frame method for applying seismic loads has summarized as follows:



**Figure 4. The cross section of metro station (unit:m)**



**Figure 5. Soil structure distortion model (unit:m)**

**Table 5. Free field deformation**

|                                  | $\Delta_{\text{free-field}}$ (m) |           |
|----------------------------------|----------------------------------|-----------|
|                                  | Station 1                        | Station 2 |
| ODE(return period of 175 years)  | 0.01                             | 0.0091    |
| MDE(return period of 2000 years) | 0.025                            | 0.02      |

It is worth mentioning that R could be achieved through using Plaxis software modeling which considers interaction between soil and structure. The soil structure distortion model has been shown in Figure 5. The results are shown in Table 6.

Triangular pressure distribution of Figure 3 for shallow tunnel is used. After analyzing the structures against the applied loads, the structures are designed for two different levels of earthquake. Then, to

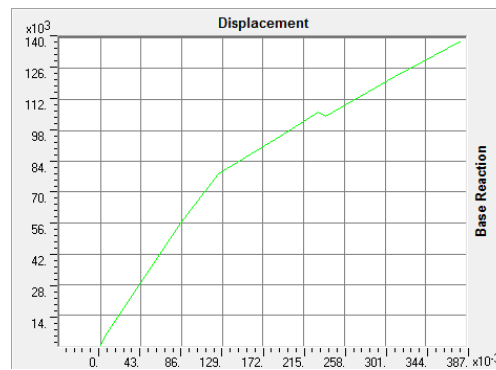
investigate the performance of structure, the structure is analyzed non-linearly and as it was mentioned, the pushover analysis was applied. Thus, monotonically increasing loads are put along the height of the structure until the structure turns into failure mechanism. In order to perform a pushover analysis, the plastic hinges are defined at the joints of the structure according to the FEMA356 bending concrete members [13]. So, the obtained graphs by the pushover analysis in 2 different levels (ODE, MDE) are presented in Figure 6.

**Table 6. The calculated R and  $\Delta_{structure}$**

|                                  |           | R     | $\Delta_{structure}$ |
|----------------------------------|-----------|-------|----------------------|
| ODE(return period of 175 years)  | Station 1 | 1.575 | 0.02                 |
|                                  | Station 2 | 1.723 | 0.0157               |
| MDE(return period of 2000 years) | Station 1 | 1.58  | 0.04                 |
|                                  | Station 2 | 1.728 | 0.0355               |

## Results and Discussion

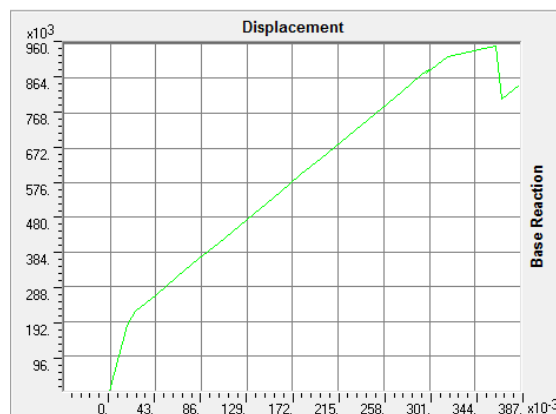
### 1. The results of designed Station 1 for ODE level.



**Figure 6. Nonlinear static pushover curve of Station 1 which had been designed for ODE level. Units: kgf, m**

Based on the results given in Figure 6, it is shown that the structure remains elastic beyond the target displacement and none of the hinges has passed Life Safety level until the displacement reaches to approximately 20 cm.

2. The results of designed Station 1 for MDE level are given in Figure 7.

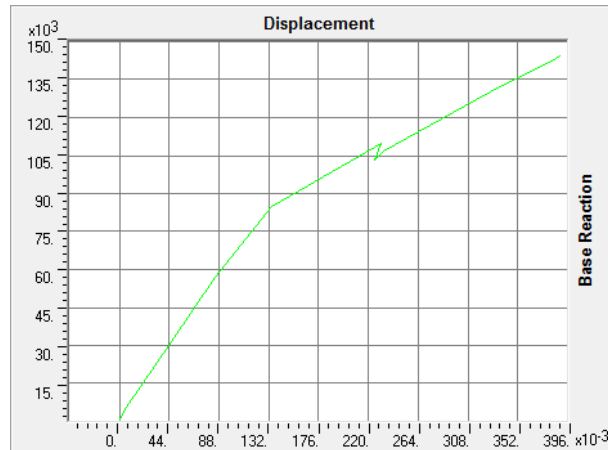


**Figure 7. Static pushover curve of Station 1 which had been designed for MDE level. Unit: kgf, m**

As it is shown in Figure 7, the structure, would be in LS level, until the deformation of the structure reaches to 30 cm.

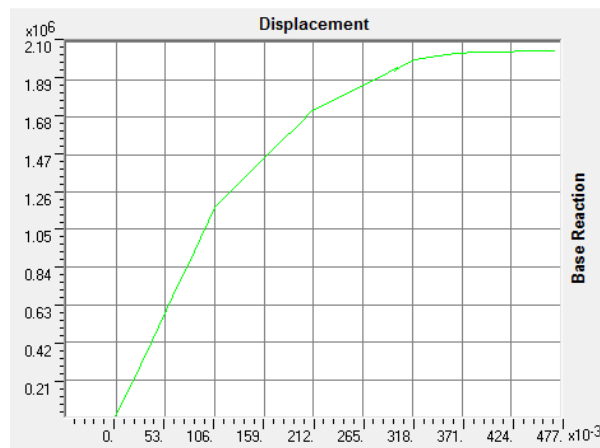
3. The results of designed Station 2 for ODE level are given in Figure 8. It is shown that until 30 cm displacement the performance of the structure would be in LS level.





**Figure 8. Static pushover curve of Station 2 which had been designed for ODE level. Unit: kgf, m**

4. The results of designed Station 2 for MDE level are given in Figure 9.



**Figure 9. Static pushover curve of Station 2 for MDE level. Unit: kgf, m**

As it is shown in Figure 9, the structure would be in LS level until the deformation of the structure reaches to 30 cm.

Pushover analysis for two different metro stations with same configurations showed that this type of structures can bear large

deformations up to 8 times relative to the design criteria. This amount of the capacity is much higher than the seismic demand of such structures. As the soil stiffness decreases, the distortion of the structure increases, so according to the deformation capacity of the structures, it is observed that this kind of structures are reliable enough in high seismic risk zones with soft soils. The results for two weaker structures (designed against ODE) support this claim. It means that the simplified frame analysis method is highly conservative and leads to an overdesigned structures.

### Conclusions

Two types of analyses were performed to design and assess two box type underground shallow subway stations in different locations along a metro railway in soft soils. The static linear analysis using simplified model of Hashash et al. (2001) method was used to design the structures of the stations and nonlinear static analysis were performed for seismic performance assessment of the structures. The pushover analysis shows that the stations, behavior remains to a large extent elastic. In this research, it was also found out that the designed structures in ODE level earthquake would remain in Life Safety level until the deformation of the structure reaches to 20 cm. For MDE level designed structures, none of the plastic hinges of the designed structure would pass Life Safety level until the displacement reaches to about 30 cm. Hence it is shown that the Hashash et al. (2001)

method overestimates the design forces and moments for the studied structures, and caused oversized results. So, as a primary result, it can be summarized that the simplified design method of subway stations should be modified to achieve more realistic and economical design results. In this situation, the performance base method is recommended to optimize the design results of the structure.

### References

1. Hashash Y. M. A., Hook J. J., Schmidt B. & Yao J. I. C., "Seismic design and analysis of underground structure", *Tunn, Undergr, Sp. Technol*, 16, (2001) 247-293.
2. Wang J. N., "Seismic Design of Tunnels: A State-of-the-Art Approach", Parsons Brinckerhoff Quade & Douglas, Inc., New York, NY, Monograph 7 (1993).
3. Wood J. H., "Earthquake-Induced Soil Pressures on Structures", Report No. EERL (1973) 73-05, California Institute of Technology.
4. Yong P. M. F., "Dynamic Earth Pressures Against A Rigid Earth Retaining Wall", Central Laboratories Report 5-85/5, Ministry of Works and Development, New Zealand (1985).
5. Liu, Jingbo, Liu, Xiang-qing., "Pushover analysis of Daikai station during the Osaka-Kobe earthquake in 1995. The 14<sup>th</sup> World Conference on Earthquake Engineering", Beijing, China (2008).
6. Liu, Jing-bo1., Liu, Xiang-qing1, XUE Ying-liang2. "Study on applicability of a pushover analysis method for seismic analysis and design of

- underground structures", Department of Civil Engineering, Tsinghua University, Beijing 100084, China; 2. China Academy of Building Research, Beijing 100013, China (2009) 01-018.
7. Owen G. N., Scholl R. E., "Earthquake engineering of large underground structures", Report No. FHWA/RD-80/195. Federal Highway Administration and National Science Foundation (1981).
  8. Kuesel T. R., "Earthquake Design Criteria for Subways", J. Struct. Div., ASCE ST6 (1969)1213-1231.
  9. Hwang R. N., Lysmer J., "Response of buried structures to traveling waves", J. Geotech. Eng. Div., ASCE 107 (GT2) (1981) 183-200.
  10. Power M. S., Rosidi D., Kaneshiro J., "Strawman: screening, evaluation, and retrofit design of tunnels", Report Draft, National Center for Earthquake Engineering Research, Buffalo, New York (1996).
  11. Chang C. Y., Power M. S., Idriss I. M., Somerville P. G., Silva W., Chen P. C., "Engineering characterization of ground motion Task II: observational data on spatial variations of earthquake ground motion", Report No. NUREG\_CR-3805, US Nuclear Regulatory Commission, Vol. 3 (1986).
  12. ACI 318, "Building Code Requirements for Reinforced Concrete", American Concrete Instit (1999).
  13. FEMA356, "Prestandard and commentary for the seismic rehabilitation of buildings", Washington: Federal Emergency Management Agency (2000).